

# RADIO FLYER

## Little Red Roadster™

model/modèle/modelo #608

For ages 1-3 years.

Pour les enfants âgés de 1 à 3 ans.

Para niños de 1 a 3 años.



Register this product at [www.radioflyer.com/register](http://www.radioflyer.com/register) for a chance to win a Free Radio Flyer product! (One winner selected every month!)

Thank you for your purchase. If you have any questions or comments, please visit the customer service section of our website:

Merci d'avoir acheté notre produit. Si vous avez des questions ou commentaires, veuillez référer notre site web dans la section de service à la clientèle:

Gracias por su compra. Si tiene preguntas o comentarios por favor visite la sección, servicio al cliente de nuestro website:

**www.radioflyer.com**

Or phone / ou composez le / o llame al 1-800-621-7613

Available weekdays 8:00 a.m. to 5:00 p.m. CST.

Please keep this sheet for future reference.

Disponible sur semaine de 8:00 heures à 17:00 heures.

Veuillez garder cette feuille comme référence.

De lunes à viernes de 8:00 a.m. à 5:00 p.m. CST.

Por favor retenga esta copia para futura referencia.

Radio Flyer Inc. / 6515 West Grand Ave. / Chicago, IL 60707

phone: 1-800-621-7613

*The Original Little Red Wagon™ - Since 1917*

2		305421 (x1)	
305423 (x1)		305398 (x1)	
305424 (x4)		305396 (x1)	
305406 (x1)		305402 (x1)	

**1** Required:  
Nécessaire:  
Requeridas:

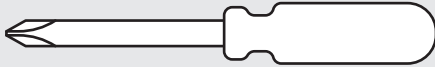

**3** Hardware Bag 305479 (x1):  
Sac matériel 305479 (x1):  
Bolsa de tornillos 305479 (x1):

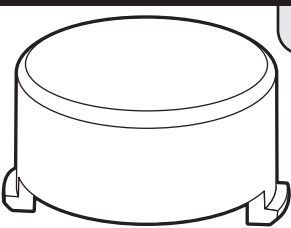

305420 (x4)

305419 (x2)

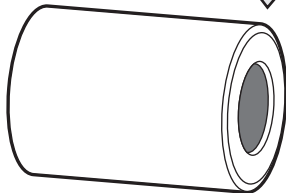

305469 (x1)



ST4.2 X 8mm

305470 (x1)



M5 X 22mm

305471 (x1)

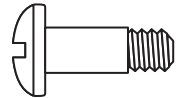

M6 X 17mm

**4** **⚠️ WARNING:**

**⚠️ AVERTISSEMENT:**

**⚠️ ADVERTENCIA:**

**ADULT ASSEMBLY REQUIRED.**

Choking hazard to children under the age of 3 years – contains small parts prior to assembly. All fasteners should be fully tightened.

**ASSEMBLAGE REQUIS PAR ADULTE.**

Risque d'étouffement pour le enfants de moins de trois ans – Contient des pièces de petite taille avant assemblage. Toutes les attaches devraient être bien serrées.

**MONTAJE REQUERIDO POR ADULTOS.**

Peligro de asfixia an niños menores de 3 años - contiene piezas pequeñas antes del montaje. Todos los seguros deben ser apretado s completamente.

Please keep instructions for future reference.

Veuillez garder les instructions comme référence aux besoins.

Mantenga por favor las instrucciones para la referencia futura.

5

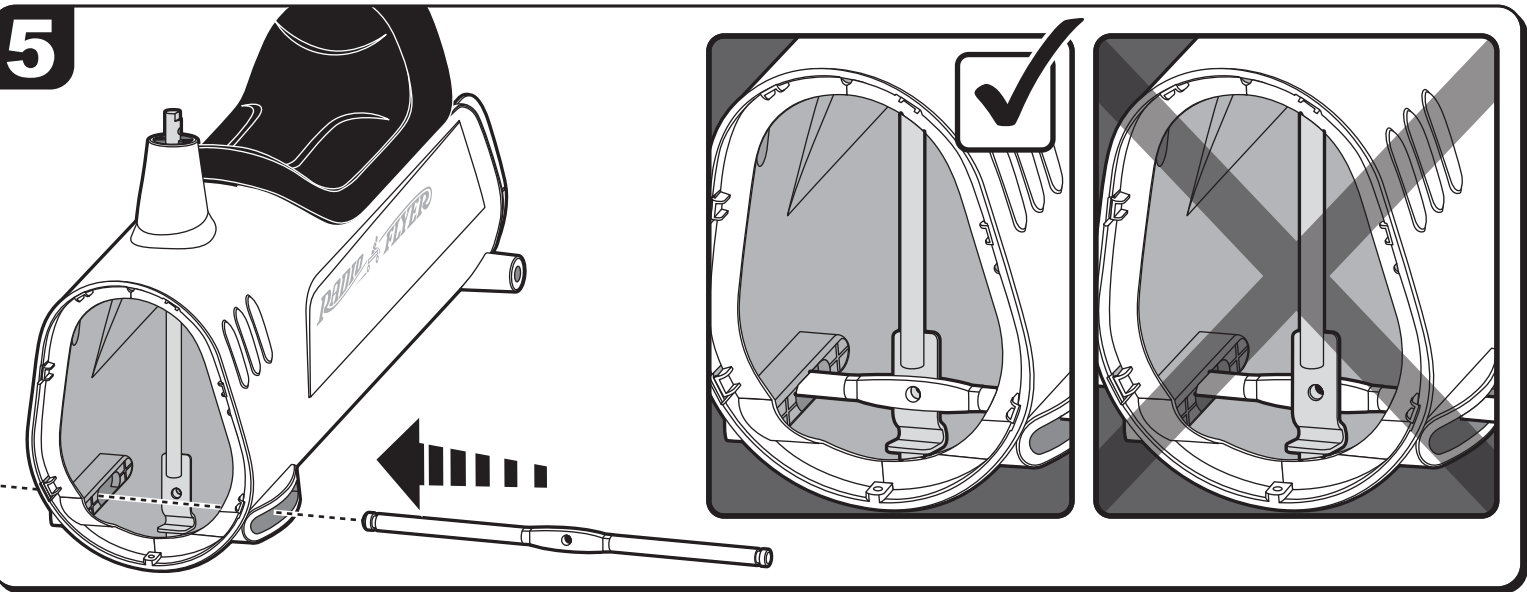

6

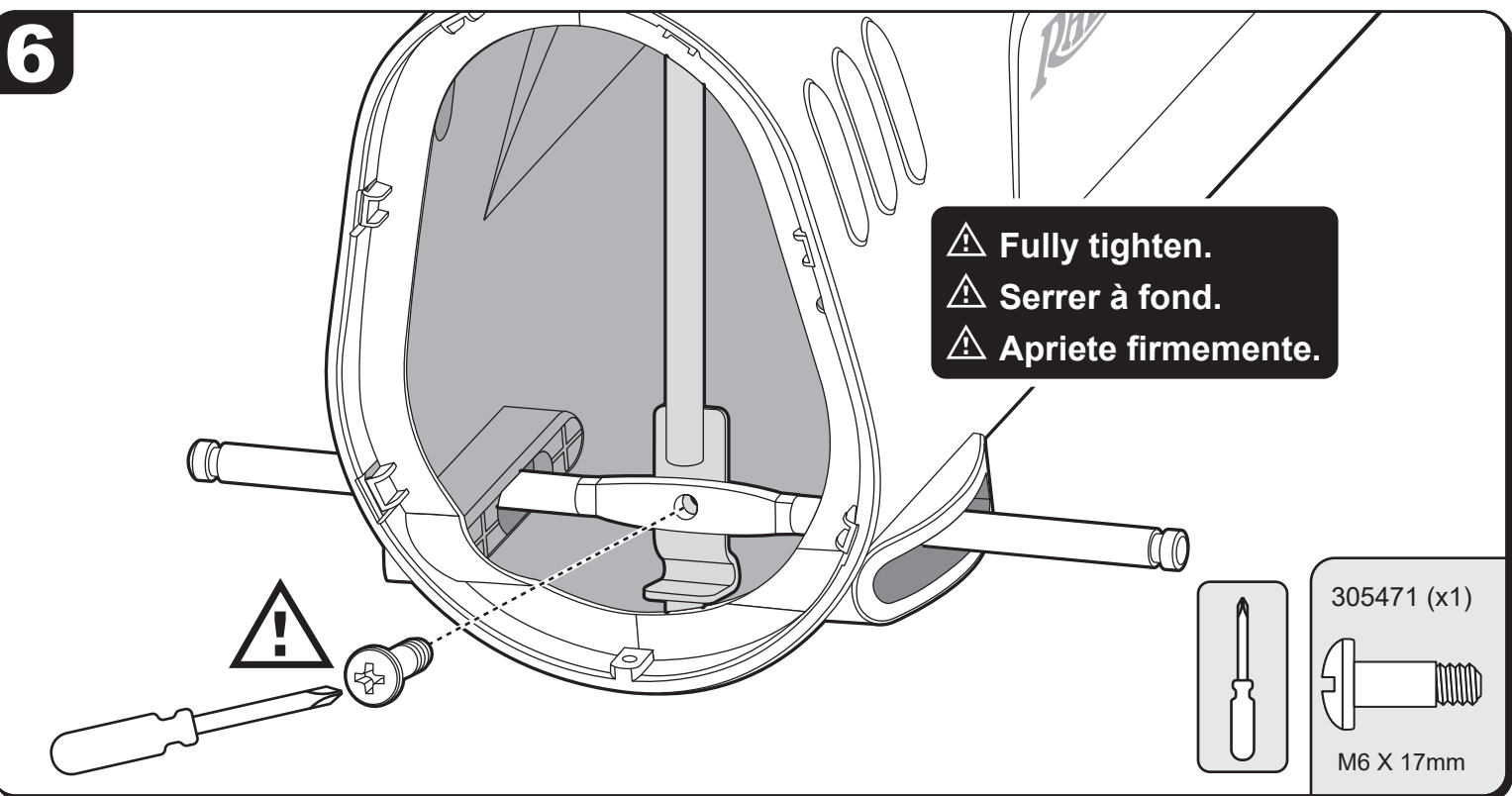

7

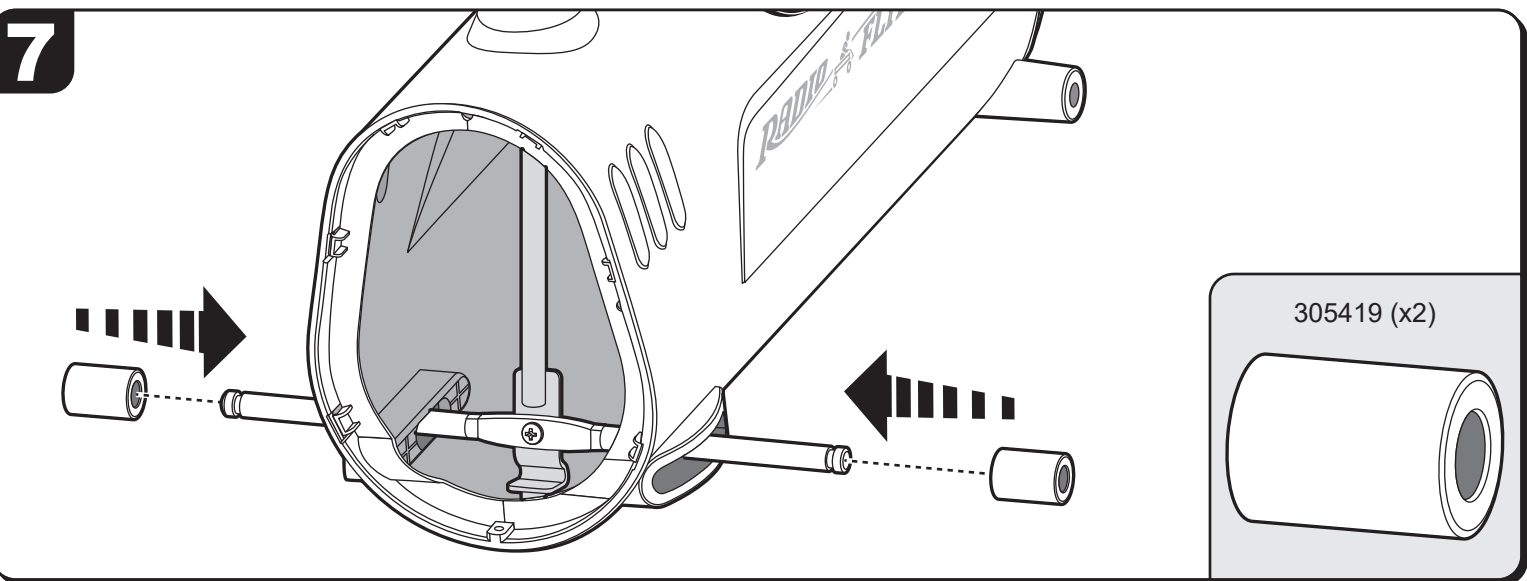

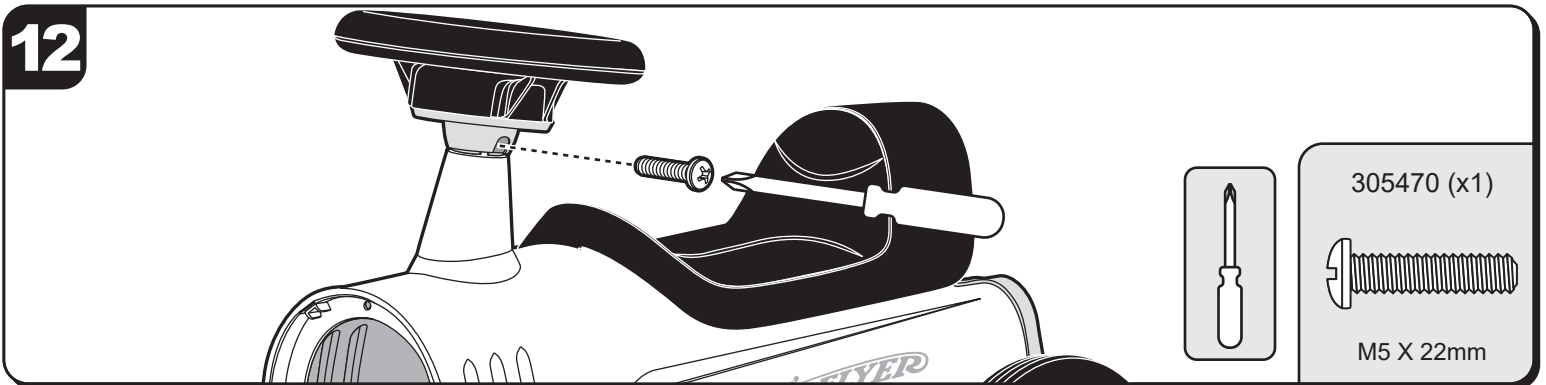
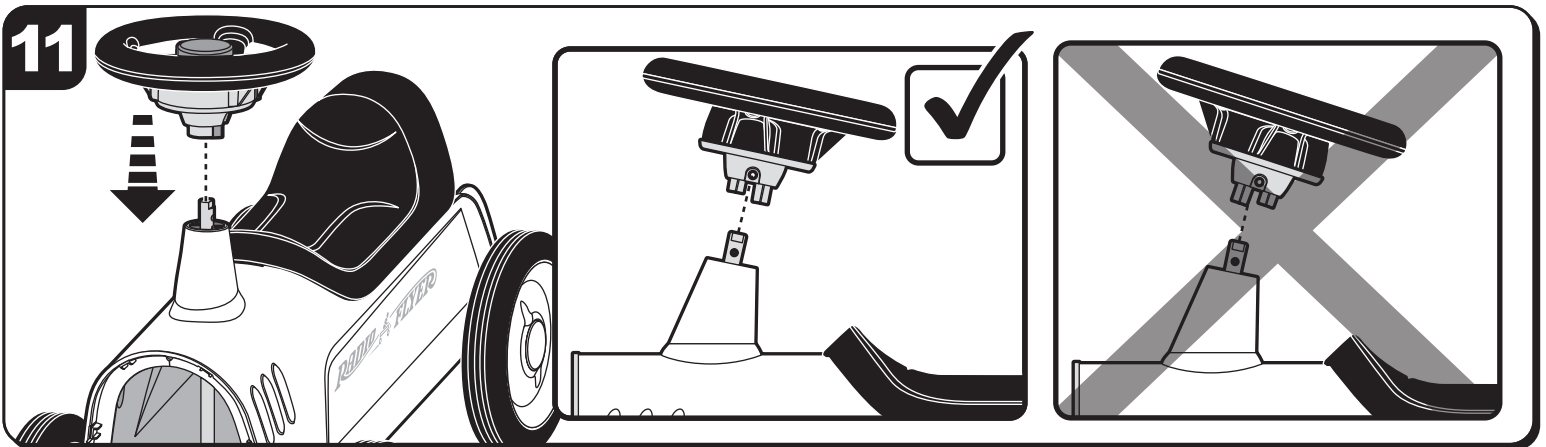
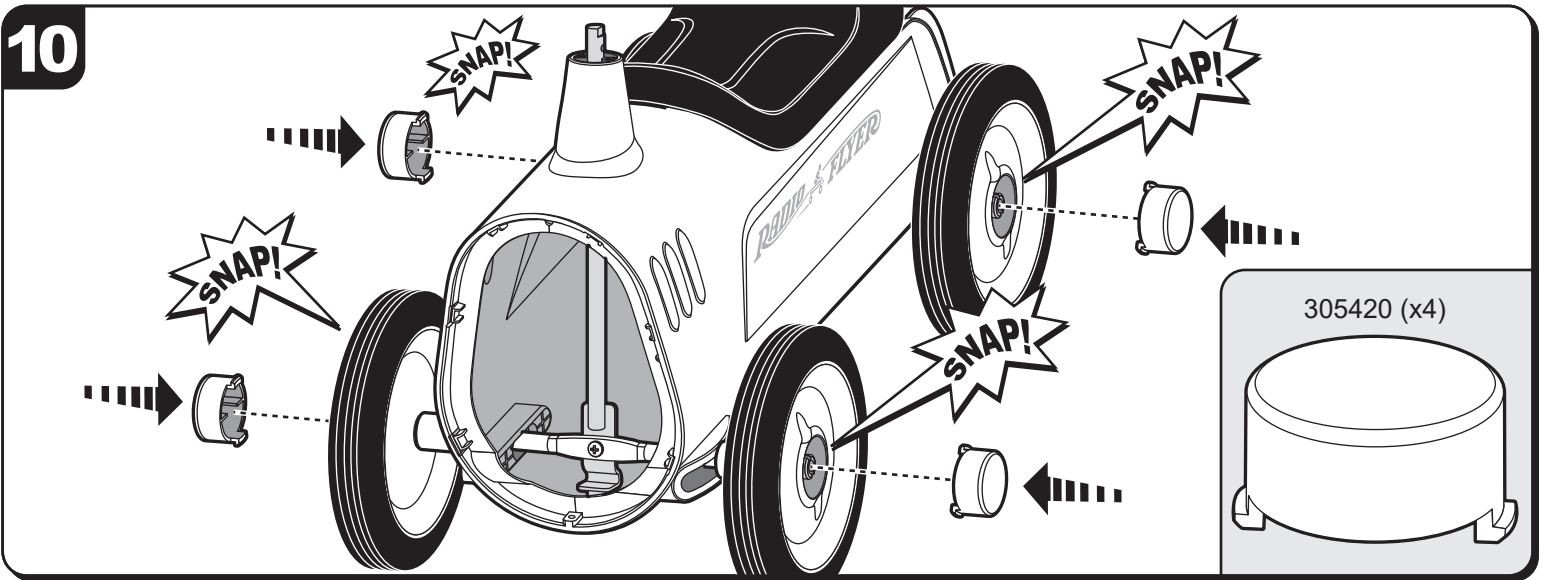
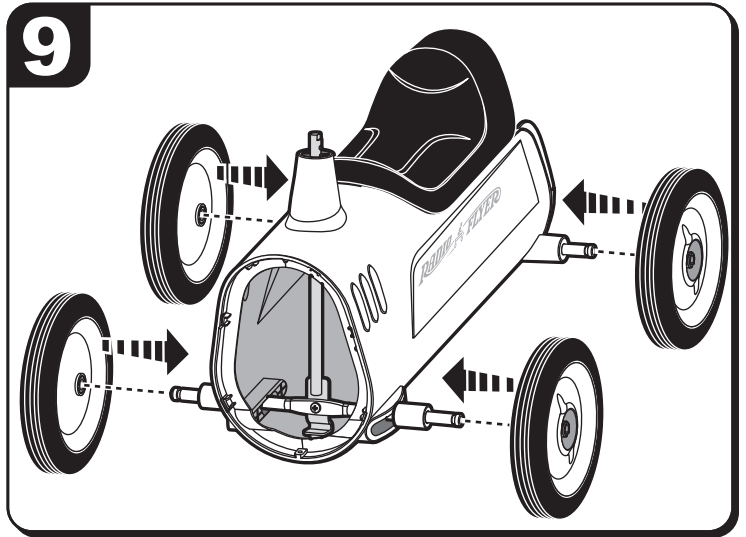
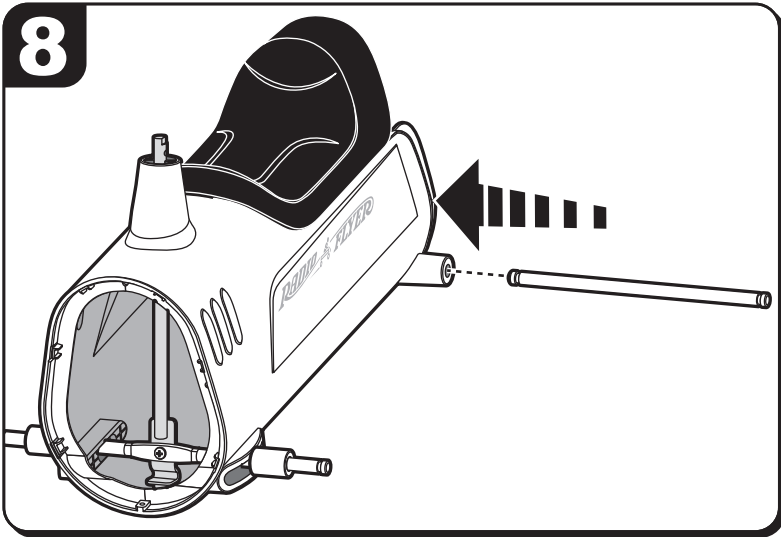

13

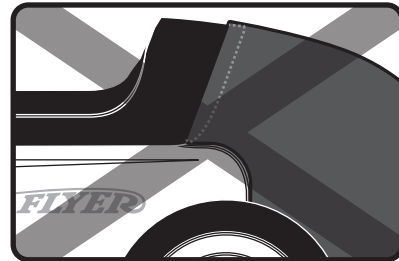
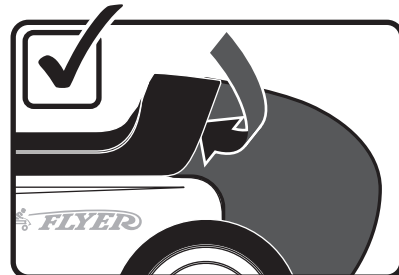
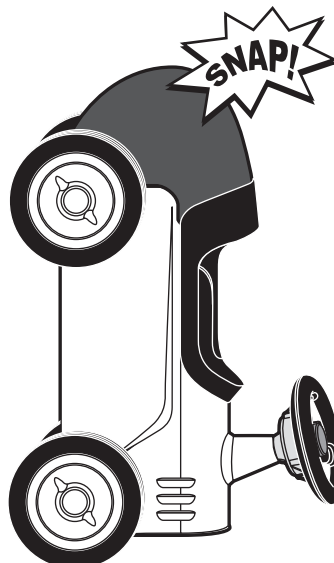
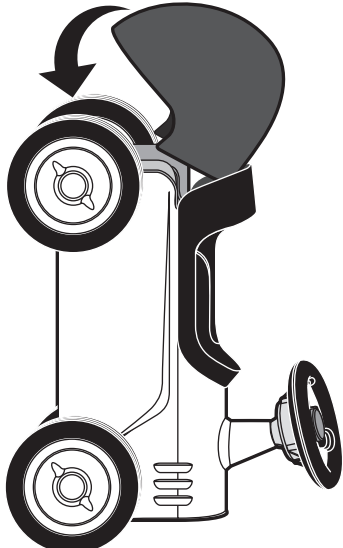
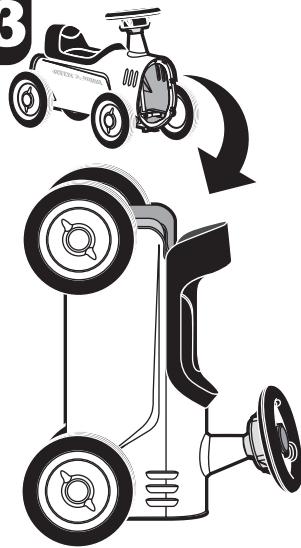

14

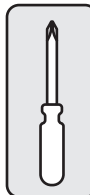
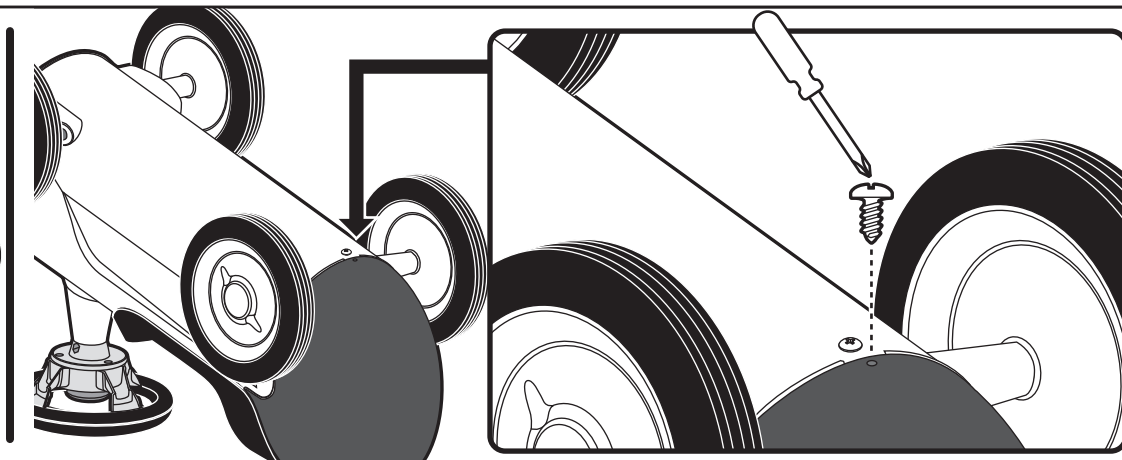
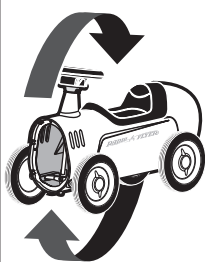

305469 (x1)



ST4.2 X 8mm

15

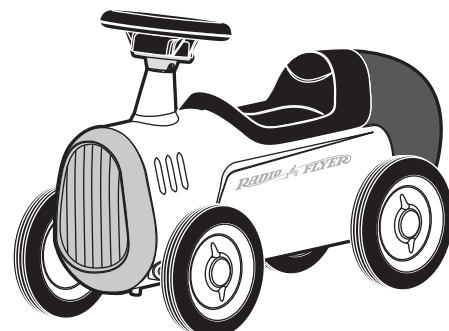
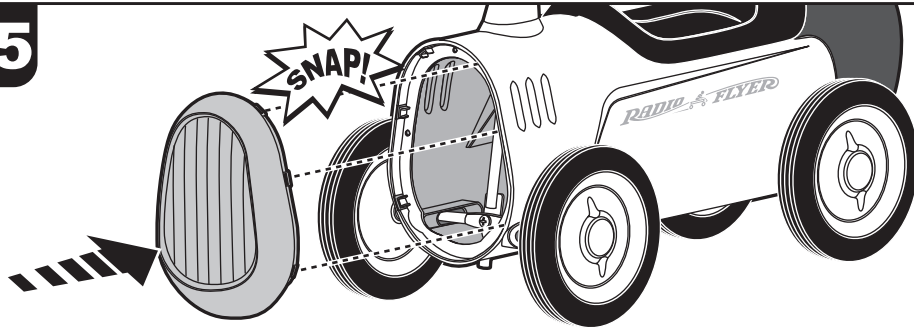

**⚠ WARNING:**  
TO AVOID SERIOUS INJURY:

- Continuous adult supervision is required.
- Never use near motor vehicles, streets, roadways, alleys, swimming pool areas, hills, steps, sloped driveways, inclines and public highways.
- Only one rider at a time.
- Always wear shoes when using the toy.
- Periodically check hardware and tighten if necessary. Replace worn or broken parts immediately.
- Never ride the toy in wet weather.
- Never ride the toy outside at night.
- Maximum weight 42.0 lbs. (19.0 kg).
- This toy is not suitable for children over 36 months due to insufficient size.
- Do not allow children to stand on the product at any time.
- We recommend riders always wear a properly fitted helmet that complies with U.S. Consumer Product Safety Commission (CPSC) Standard 16 CFR 1203.
- Skill is required to avoid falls or collision.

**⚠ AVERTISSEMENT:**  
POUR ÉVITER TOUTE BLESSURE GRAVE:

- La supervision continu d'un adulte est exigée.
- Ne jamais utilisez près des véhicules à moteur, des rues, des chaussées, des allées, au environs des piscine, des collines, des marches, est des descente en pente des allées, des pentes et des autoroutes publiques.
- Seulement un cavalier à la fois.
- Ne conduisez jamais sans chaussures.
- Vérifiez souvent les boulons et écrous et resserrez les si nécessaire. Remplacez le pièces usées out endommagées immédiatement.
- Ne conduise pas cette jouet par temps de pluie.
- Ne conduise pas cette jouet la nuit.
- Charge maximale 19.0 kg (42.0 livres).
- En raison de sa taille, ce jouet ne convient pas aux enfants de plus de 36 mois.
- Toujours interdire aux enfants de se maitre debout dans la voiture.
- Nous recommandons aux utilisateurs de porter systématique ment un casque bien attaché, conformément à la norme 16 CFR 1203 de l'U.S. Consumer Product Safety Commission (CPSC)
- Il faut une certaine habileté pour éviter les chutes et les collision.

**⚠ ADVERTENCIA:**  
PARA EVITAR LESIONES GRAVES:

- La supervisión adulta continua requerida.
- Nunca uso cerca de automóviles, calles, carreteras, callejones, áreas de piscinas, colinas, pasos, calzadas inclinas, inclinaciones y carreteras públicas.
- Solmente un jinete a la vez.
- Use siempre los zapatos.
- Compruebe el hardware y apriete periódicamente en caso de necesidad. Reemplace inmediatamente las piezas dañadas o gastadas.
- Nunca usarlo si está lloviendo.
- Nunca usarlo de noche.
- Peso máximo 19.0 kg (42.0 lbs.).
- Este juguete no es adecuado para niños de más de 36 meses, debido al tamaño insuficientes.
- No permita que los niños se paren en el carrito en ningún momento.
- Se recomienda que el conductor utilice siempre un casco adecuado que cumpla con el estándar 16 de código federal de regulaciones 1203, de la Comisión de seguridad de productos para el consumidor (CPSC) de Estados Unidos
- La habilidad de manejo se requiere para evitar caídas o colisión.